

## INSTRUCTION MANUAL FOR ANVIL SET (208-001)

### ➤ Specification

This anvil set enlarges the possibilities of a regular caliper. All are holders slid on the measuring jaw of the caliper. The anvil set makes it possible to execute measurements, which are not possible with a regular caliper, such as measuring internal grooves and center distance.



Code
208-001

### ➤ Features

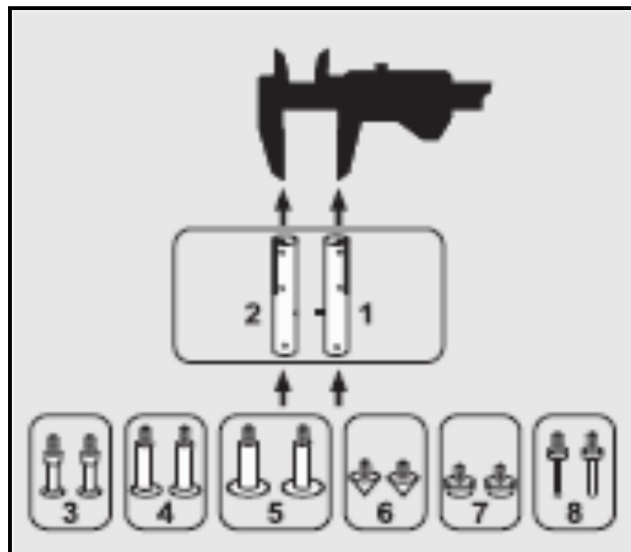

## INSTRUCTION MANUAL FOR ANVIL SET (208-001)

1. Anvil holder, right/left with thread M 2.5

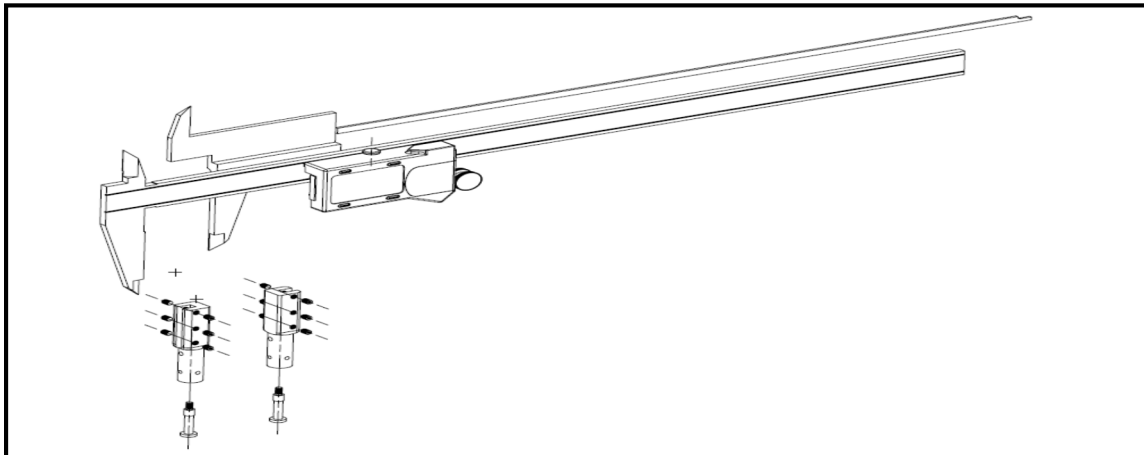
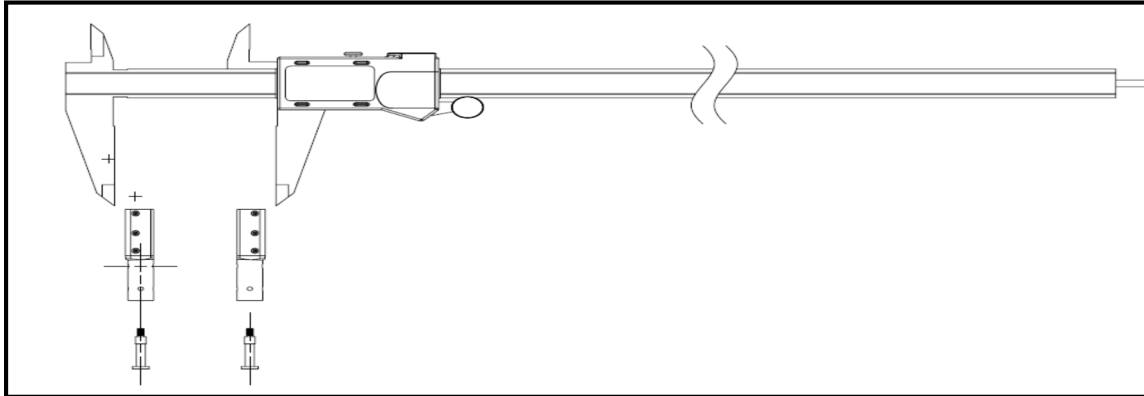

2. Pair of anvil with disc  
 Available disc diameter  $\varnothing 6 / \varnothing 10 / \varnothing 12.5$

$\varnothing$		
6 mm	> 16 mm	> 4 mm
10 mm	> 20 mm	> 1 mm
12.5 mm	> 22 mm	> 0 mm

**3,4,5**  
 Disc anvil for internal measurements.

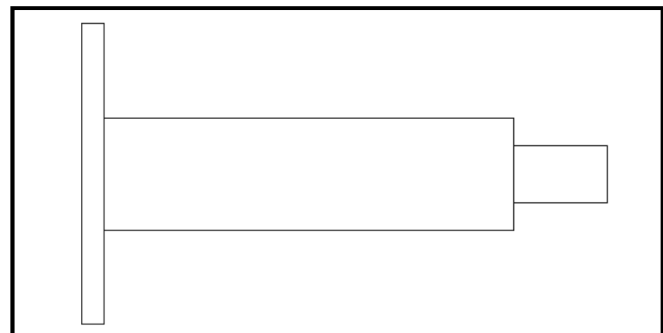

## INSTRUCTION MANUAL FOR ANVIL SET (208-001)

3. Pair of anvil with 60° cone  
Available diameter  $\varnothing 9 / \varnothing 12.5$

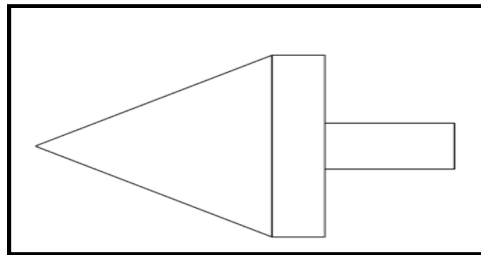
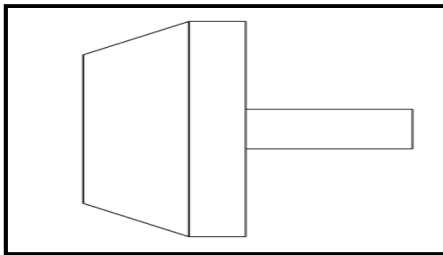
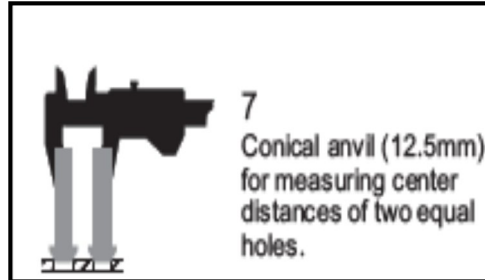
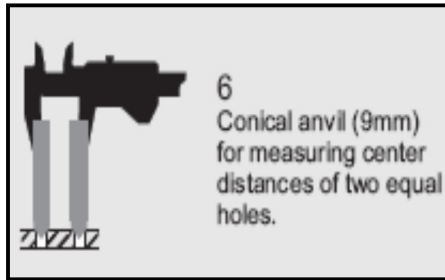

4. Pair of anvil with cylindrical surface 1.5 mm

